

2
1/1
60x60
1128x1128

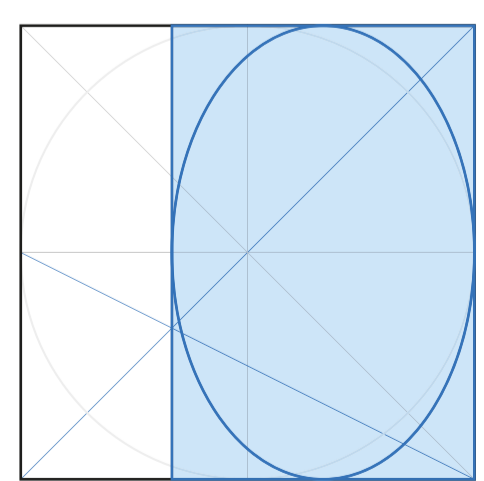

3
3/2
60x90
1128x752

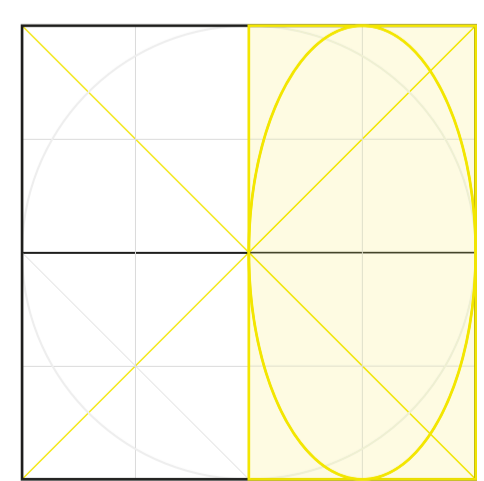

4
4/2
60x30
1128x564

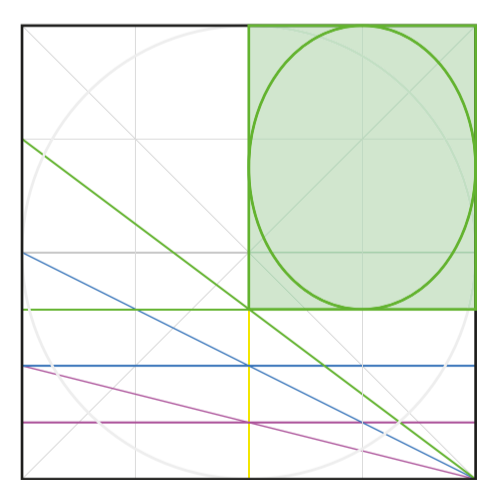

7
8/7
37,5x30
705x564

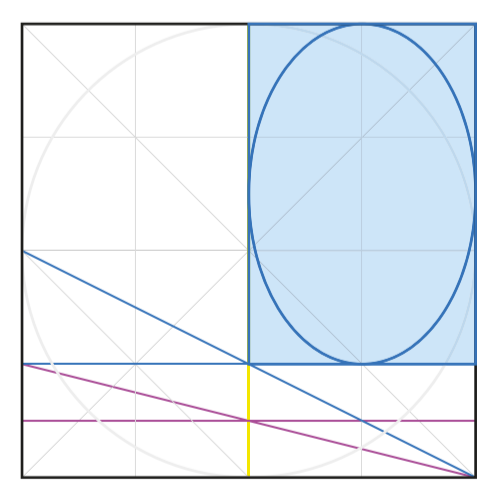

6
6/4
45x30
846x564

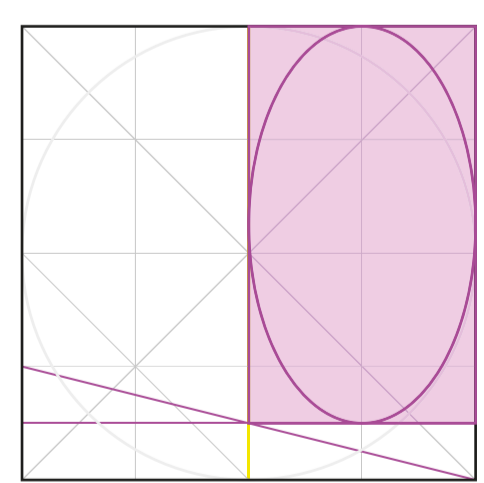

5
7/4
52,5x30
987x564

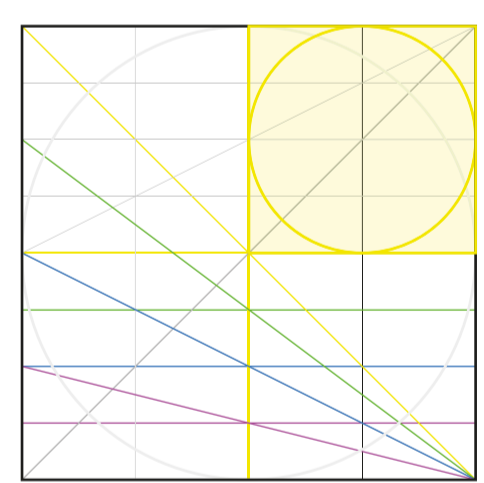

8
8/8
30x30
564x564

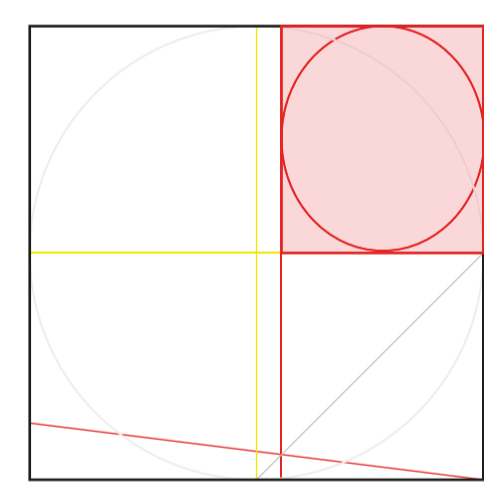

9
9/8
30x26,7
564x501

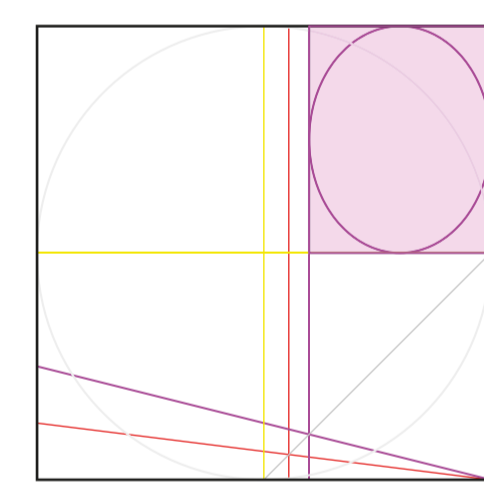

10
10/8
30x24
564x451,2

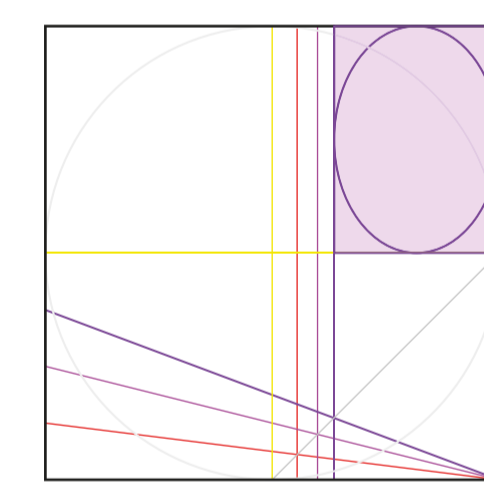

11
11/8
30x21,8
564x410,2

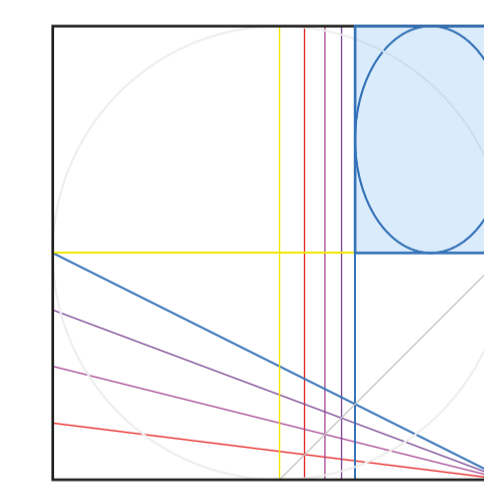

12
12/8
30x20
564x376

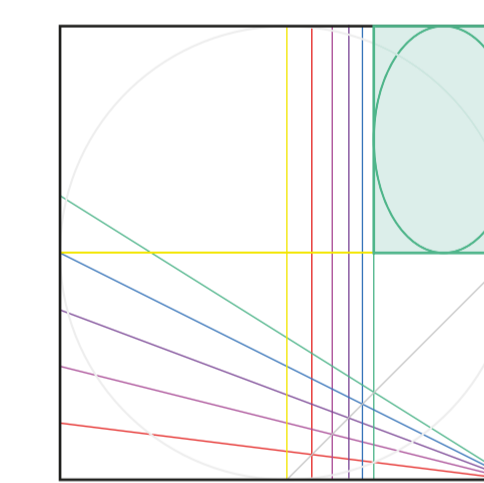

13
13/8
30x18,5
564x347

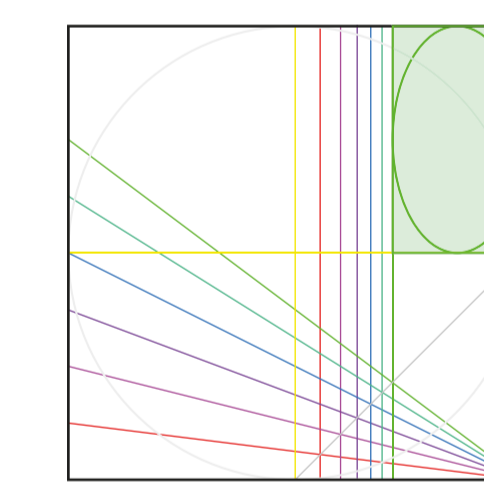

14
14/8
30x17,1
564x322,3

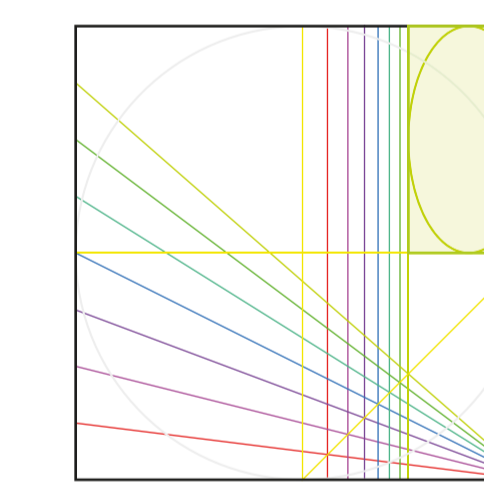

15
15/8
30x16
564x300,8

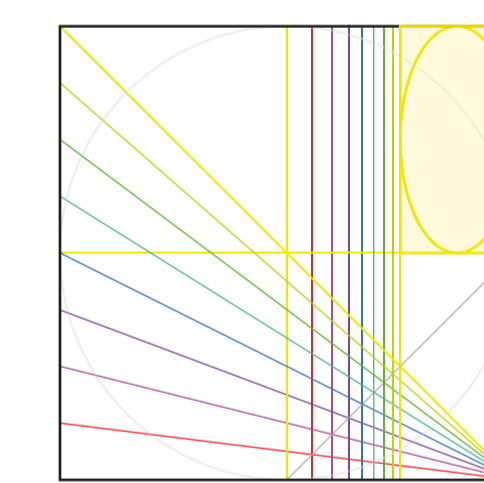

16
16/8
30x15
564x282

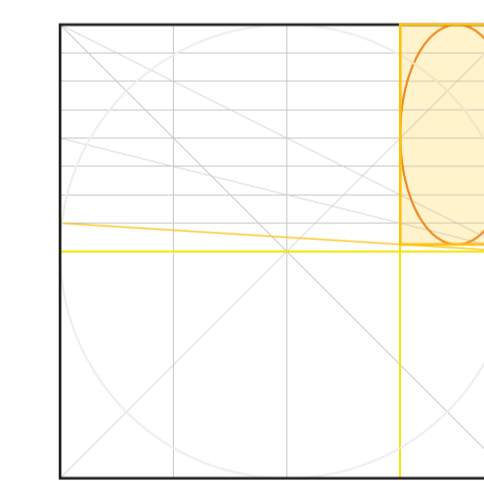

17
31/16
29,1x15
546,4x282

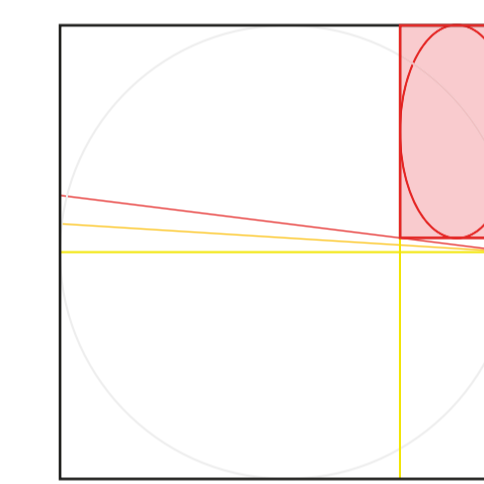

18
30/16
28,3x15
528,8x282

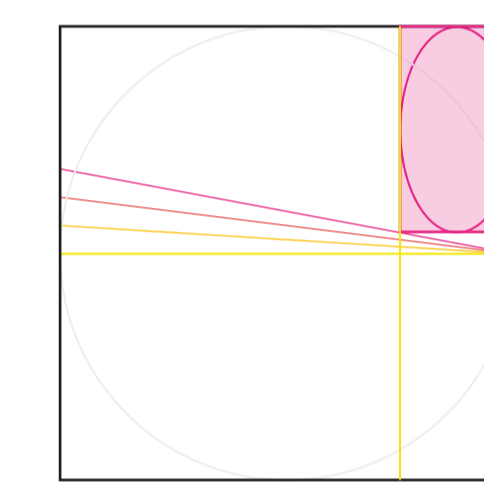

19
29/16
27,2x15
511,1x282

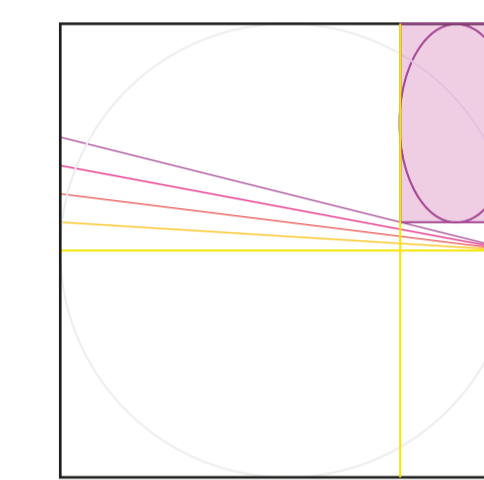

20
28/16
26,3x15
493,5x282

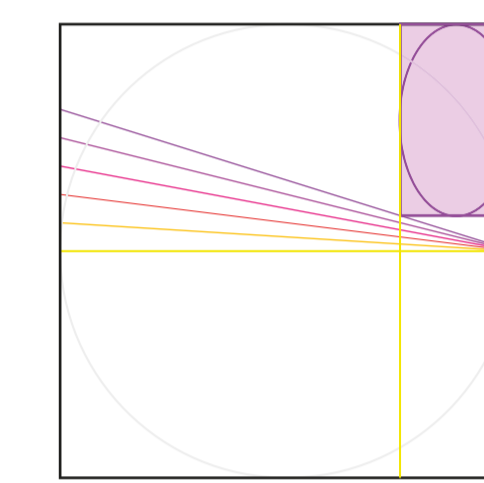

21
27/16
25,3x15
475,9x282

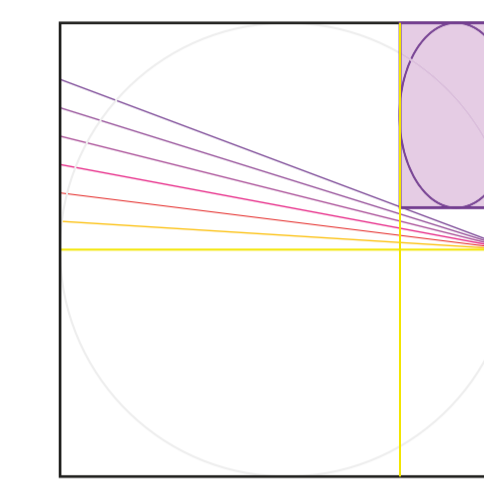

22
26/16
24,4x15
458,3x282

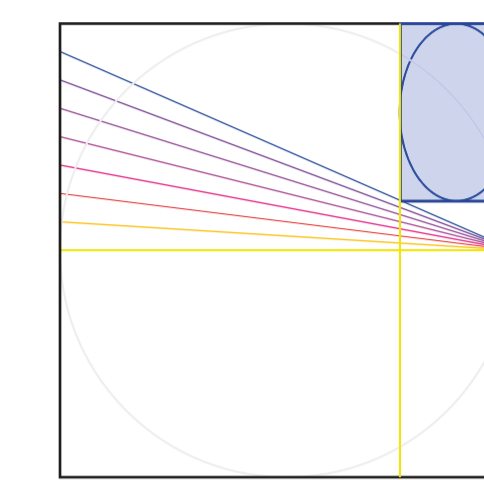

23
25/16
23,4x15
440,6x282

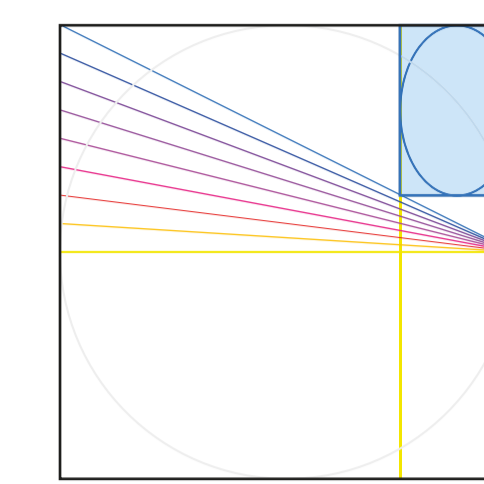

24
24/16
23,1x15
546,4x282